



linea accessori

Per la vostra porta chiedete sempre accessori originali Aluform. Le nostre proposte non sono mai affidate al caso: da sempre selezioniamo i migliori prodotti per garantirvi coerenza nel design ma anche e soprattutto funzionalità ed inalterabilità nel tempo.

For Your door, demand always Aluform original accessories. Our propose are never entrusted to the case: we select always the best products to guarantee an harmony design but also and above functional and unchanging characteristics in the long run.

ingresso



Collezione P.V.D.

Le maniglie e gli accessori in PVD sono realizzati con ottone di prima qualità. Uno speciale trattamento protettivo al titanio blocca ogni possibile processo di ossidazione dell'ottone che resterà brillante come nuovo per tutta la vita.

Collezione Classic

A chi piace lo stile inconfondibile degli accessori classici in ottone vissuto ed invecchiato per azione naturale degli agenti atmosferici. Questa particolare linea di prodotto è ottenuta mediante un trattamento manuale che non contrasta eventuali processi di ossidazione.

Collezione Cromo

Una linea di maniglie ed accessori di colorazione moderna e resistente, realizzata attraverso un bagno al cromo, successivamente spazzolato a mano per ottenere un effetto di satinatura irregolare. La resistenza all'ossidazione di questi accessori è particolarmente elevata ma non illimitata.

Collezione Inox

Maniglie ed accessori unici ed indistruttibili realizzati in acciaio inox Aisi 316, la migliore lega dell'acciaio inossidabile.

Numeri civici

Con CIVIC eleganza e funzionalità si uniscono per un prodotto innovativo, studiato in armonia con lo stile dei nostri maniglioni e delle pensiline NEWENTRY® per rendere ancora più esclusivo il tuo ingresso.

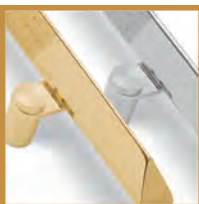

P.V.D. Collection

Our PVD handles and accessories are made with best quality brass. A special titanium protecting treatment blocks every possible oxidation process of the brass that will be bright like a new one and for all its life.

Classic Collection

The brand for every one loves the unmistakable style of classic accessories in lived and aged brass by share natural of the atmospheric agents. This particular line of product is obtained by means of a manual treatment that does not contrast the eventual processes of oxidation.

Chrome Collection

A brand of handles and accessories of realized modern and resistant coloration through a chrome-bath and brushed by hand subsequently, to obtain an irregular effect of glazing. The resistance to the oxidation of these accessories is particularly elevated but not limitless.

Inox Collection

Only and indestructible handles and accessories realize in stainless steel Aisi 316, the best alloy of the stainless steel.

House numbers

With CIVIC line elegance and function come together for an innovative product, designed in harmony with the style of our handles and NEWENTRY® canopies to make it even more unique your entrance.

GAIA

A 800

Acciaio inox
lucido-satinato oro PVD

A 700

Acciaio inox
lucido-satinato



A 700 P

Acciaio inox
lucido-satinato

A 800 P

Acciaio inox
lucido-satinato oro PVD



BOOMERANG

A 805
Acciaio inox
lucido-satinato oro PVD

A 705
Acciaio inox
lucido-satinato

A 705 P
Acciaio inox
lucido-satinato

A 805 P
Acciaio inox
lucido-satinato oro PVD



HANDLES ENTIRELY DESIGNED
AND PRODUCED IN ITALY

TREVIS



A 832 P
*Acciaio inox
lucido-satinato oro PVD*

A 732 P
*Acciaio inox
lucido-satinato*

A 733 P
*Acciaio inox
lucido-satinato*

A 833 P
*Acciaio inox
lucido-satinato oro PVD*

GAIA

A 701 P

*Acciaio inox
lucido-satinato*

A 801 P

*Acciaio inox
lucido-satinato oro PVD*

A 802 P

*Acciaio inox
lucido-satinato oro PVD*

A 702 P

*Acciaio inox
lucido-satinato*

A 703 P

*Acciaio inox
lucido-satinato*



A 701
Acciaio inox
lucido-satinato

A 801
Acciaio inox
lucido-satinato oro PVD

A 802
Acciaio inox
lucido-satinato oro PVD

A 702
Acciaio inox
lucido-satinato

A 703
Acciaio inox
lucido-satinato

IDRA



A 812 P
Acciaio inox
lucido-satinato oro PVD

A 712 P
Acciaio inox
lucido-satinato

A 713 P
Acciaio inox
lucido-satinato

A 813 P
Acciaio inox
lucido-satinato oro PVD

AURORA

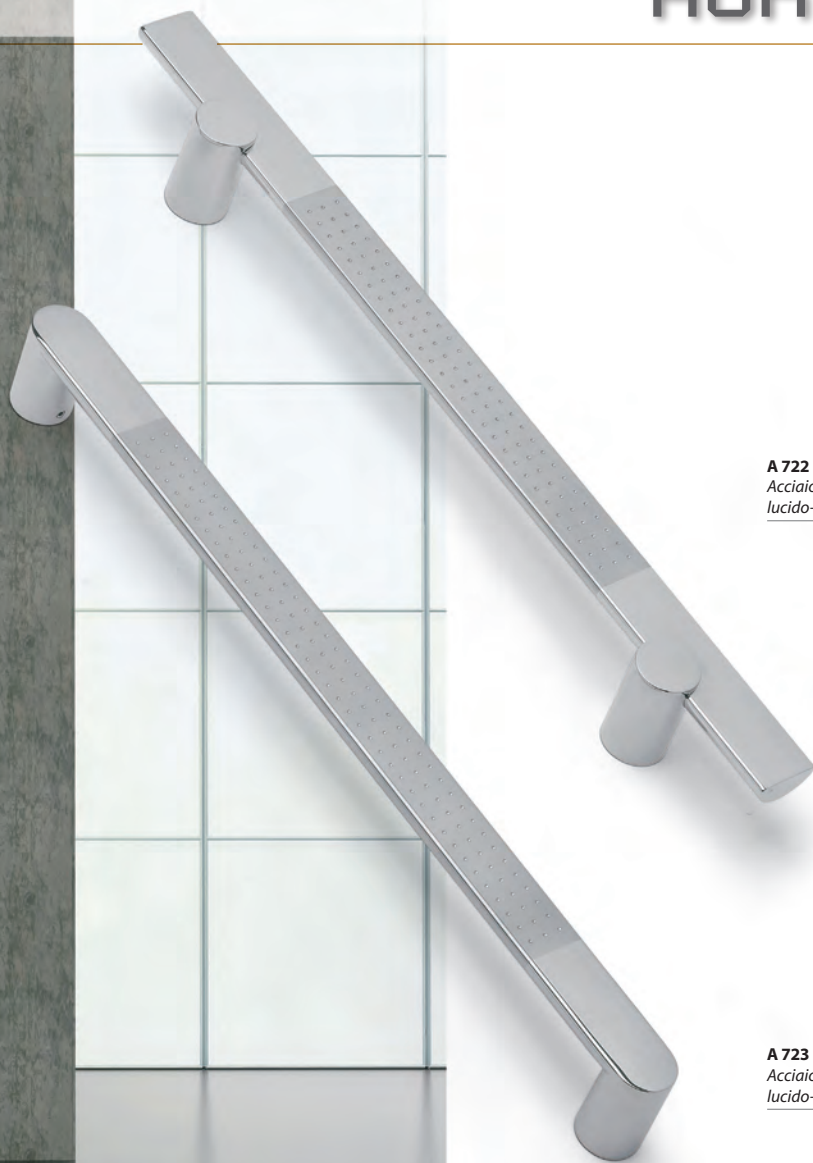

A 722 P
Acciaio inox
lucido-satinato

A 723 P
Acciaio inox
lucido-satinato

TREVIS

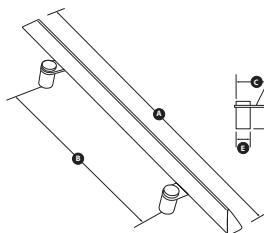
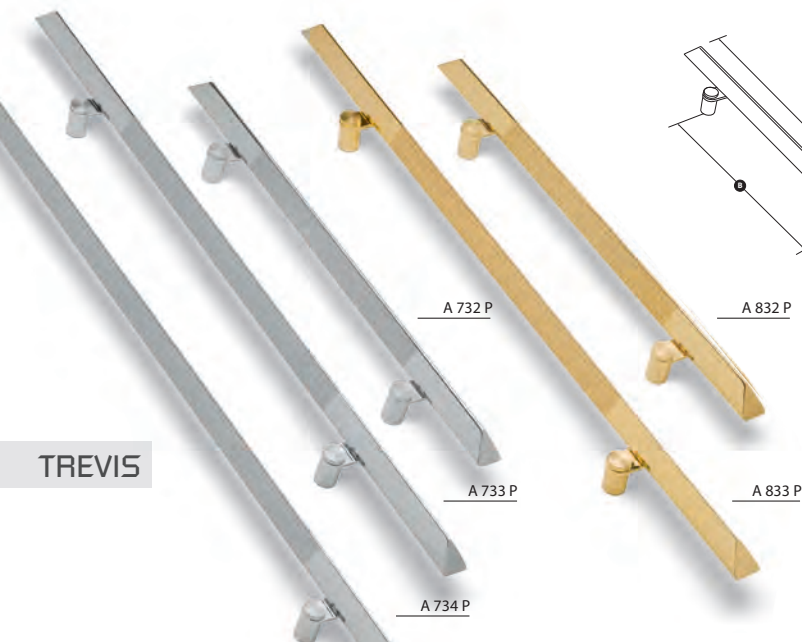

articolo	misure mm				
	A	B	C	D	E
A 732 P	800	500	80	80	32
A 733 P	1200	750	80	80	32
A 734 P	1700	1300	80	80	32
A 832 P	800	500	80	80	32
A 833 P	1200	750	80	80	32

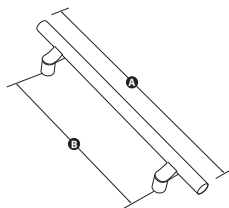
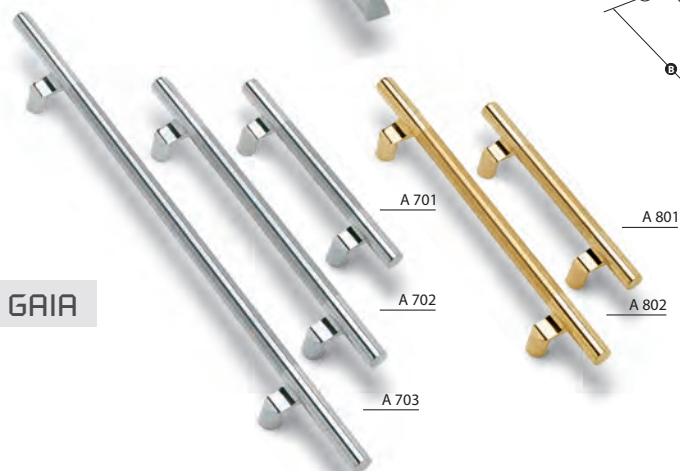

articolo	misure mm				
	A	B	C	D	E
A 701	400	250	76	75	32
A 702	600	425	76	75	32
A 703	1000	700	76	75	32
A 801	400	250	76	75	32
A 802	600	425	76	75	32

GAIA



A 701 P

A 702 P

A 703 P

A 704 P

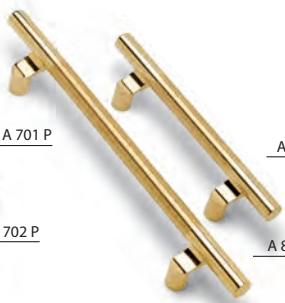

A 801 P

A 802 P

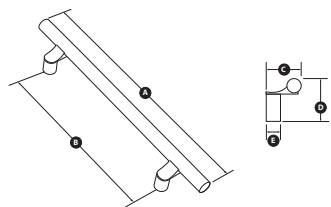

articolo	misure mm				
	A	B	C	D	E
A 701 P	400	250	76	75	32
A 702 P	600	425	76	75	32
A 703 P	1000	700	76	75	32
A 704 P	1700	1300	76	75	32
A 801 P	400	250	76	75	32
A 802 P	600	425	76	75	32

GAIA



A 700 P

A 700



A 800 P

A 800



A 705 P

A 705

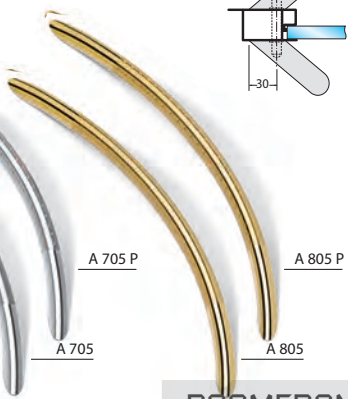

A 805 P

A 805

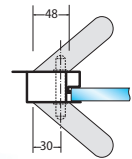

GAIA

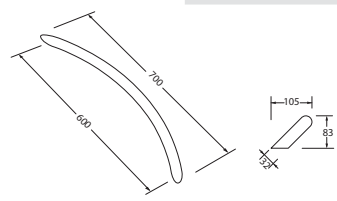
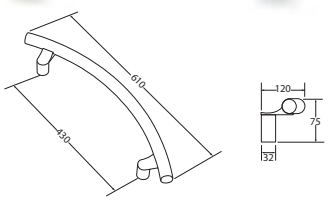

BOOMERANG

IDRA

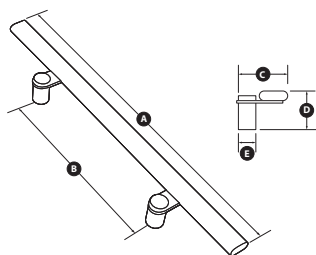

articolo	misure mm				
	A	B	C	D	E
A 712 P	600	400	80	65	32
A 713 P	1000	700	80	65	32
A 812 P	600	400	80	65	32
A 813 P	1000	700	80	65	32

AURORA

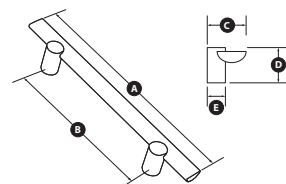
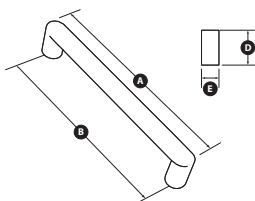
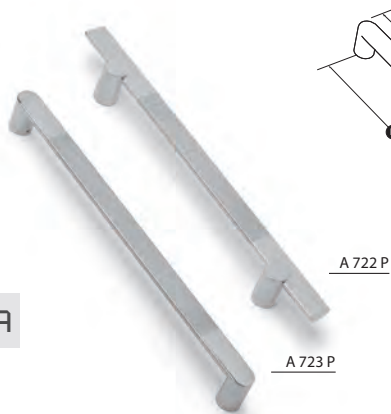

articolo	misure mm				
	A	B	C	D	E
A 722 P	600	425	58	65	38
A 723 P	600	562	-	62	38

SISTEMI DI FISSAGGIO

Fissaggio di serie con vite passante inclusi nella confezione della maniglia

Fissaggi speciali da ordinare separatamente

Fissaggio singolo passante per Alluminio, Legno, PVC

Fissaggio doppio passante per Alluminio, Legno, PVC, Vetro

Fissaggio singolo o doppio non passante per Alluminio, Legno, PVC

Fissaggio singolo passante per Vetro

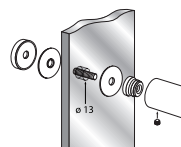
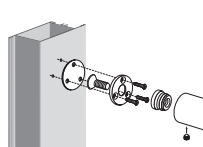
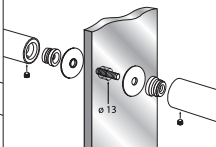
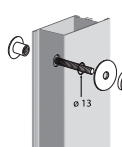

Per maniglie Mod. Trevis, Gaia, Idra:
Cod. ATR732 Inox - Cod. ATR832 PVD
 Per maniglia Mod. Aurora:
Cod. ATR738 Inox - Cod. ATR838 PVD
 Per maniglia Mod. Boomerang il fissaggio è compreso nella confezione

Per maniglie Mod. Trevis, Gaia, Idra, Aurora, Boomerang:
Cod. ATP7 Inox - Cod. ATP8 PVD



A 614

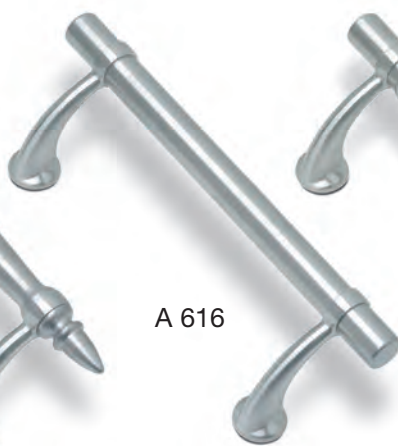

A 616



A 617



A 618



A 670

ACCIAIO INOX

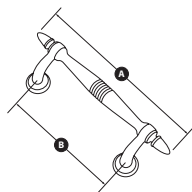

articolo	misure (mm)					attacco
	A	B	C	D	E	
A. 614	334	230	90	80	34	P-R*
A. 616	306	230	90	80	34	P-R*
A. 617	306	230	90	80	34	P-R*
A. 618	387	230	126	84	34	P-R*
A. 670	333	230	95	85	34	P-R*

attacco con rosetta - R

attacco passante - P



*Attacco con rosetta da ordinare separatamente

COD. ATR6



A 681



A 680



A 685



A 689



A 687



A 688

ACCIAIO INOX

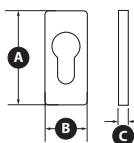
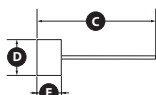

articolo misure (mm) attacco

articolo	A	B	C	D	E	attacco
A. 680	420	250	157	52	32	P-R*
A. 681	394	280	176	52	32	P-R*
A. 682	372	250	212	52	32	P-R*
A. 683	300	185	174	52	32	P-R*
A. 685	200	125	194	52	32	P-R*
A. 686	200	125	217	52	32	P-R*
A. 687	200	125	217	52	32	P-R*
A. 688	200	125	217	52	32	P-R*
A. 689	200	125	194	52	32	P-R*
A. 691	420	250	117	52	32	P-R*

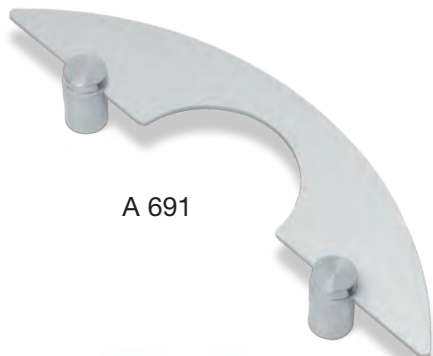

A 691



A 682

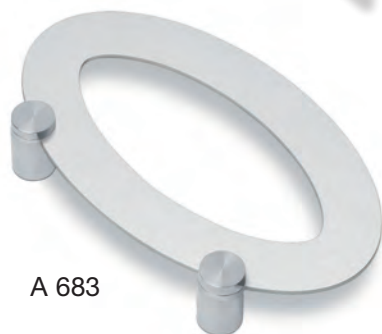

A 683



A 676

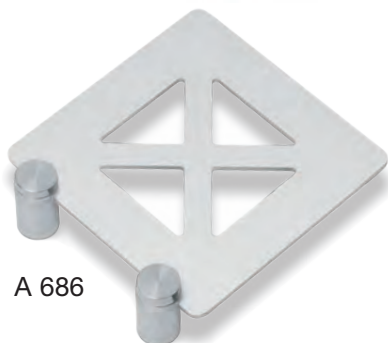

A 686



A 678



A 679

articolo	misure (mm)					attacco
	A	B	C	D	E	
A. 676	67	27	4	.	.	.
A. 678	69	29	4	.	.	.
A. 679	62	25	4	.	.	.

attacco con rosetta · R

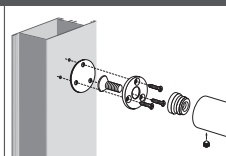

*Fissaggio singolo non passante da ordinare separatamente
COD. ATR732

attacco passante · P





A 415



A 416



A 417



A 470



A 414



A 409



A 460



A 406

OTTONE PVD

articolo misure (mm) attacco

	A	B	C	D	E	
A. 406	295	230	80	75	37	R - P
A. 409	320	280	80	88	45	R - P
A. 414	336	230	90	68	44	R - P
A. 415	315	235	90	68	44	R - P
A. 416	307	230	90	68	44	R - P
A. 417	309	230	90	68	44	R - P
A. 460	260	215	115	79	45	R - P
A. 470	340	235	94	73	44	R - P

attacco con rosetta - R

attacco passante - P

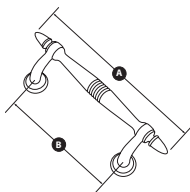



A 420



A 440



A 425



A 430



A 465 (2)



A 40 (2)



A 468



A 55 (2)



A 479



A 480



A 476 (1)

(1) Per utilizzare il DEFENDER, il cilindro deve sporgere dalla porta da 8 a 10 mm.
 (2) Questi articoli non hanno il trattamento PVD

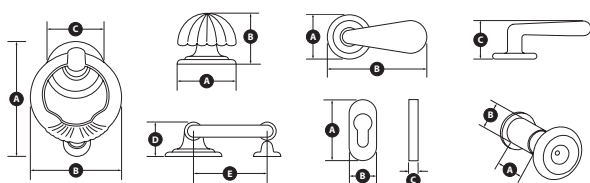

articolo	misure [mm]					attacco
	A	B	C	D	E	
A. 40	18/45	14
A. 55	50	104	60	.	.	R
A. 420	155	118	79	60	100	R
A. 425	163	110	79	63	107	R
A. 430	81	83	.	.	.	R
A. 440	165	135	79	58	110	R
A. 465	50	150	66	.	.	.
A. 468	61	95	60	.	.	.
A. 476	70	30	15	.	.	.
A. 479	61	31	10	.	.	.
A. 480	61	31	10	.	.	.



A 314

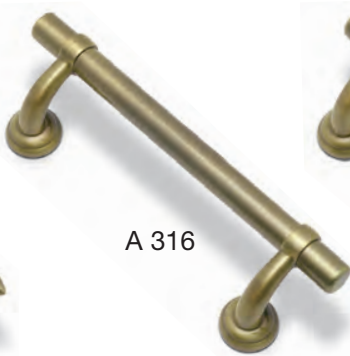

A 316



A 317



A 360



A 370

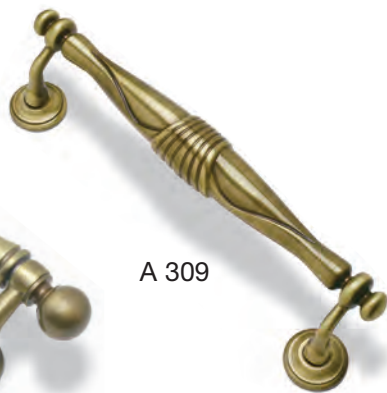

A 309

OTTONE CLASSICO

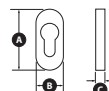
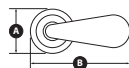
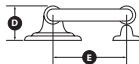
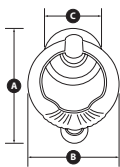
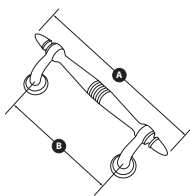



A 320



A 340



A 325



A 330



A 368



A 355



A 379



A 380

articolo misure (mm) attacco

	A	B	C	D	E	
A. 309	320	280	80	88	45	R - P
A. 314	336	230	90	68	44	R - P
A. 316	307	230	90	68	44	R - P
A. 317	309	230	90	68	44	R - P
A. 320	155	118	79	60	100	R
A. 325	163	110	79	63	107	R
A. 330	81	83	-	-	-	R
A. 340	165	135	79	58	110	R
A. 355	50	104	60	-	-	-
A. 360	260	215	115	79	45	R - P
A. 368	61	95	60	-	-	-
A. 370	340	235	94	73	44	R - P
A. 379	61	31	10	-	-	-
A. 380	61	31	10	-	-	-

attacco con rosetta · R



attacco passante · P





A 515



A 516



A 517



A 570



A 506



A 514



A 509



A 560



A 503

A 502

CROMO SATINATO

articolo

misure (mm)

attacco

attacco con rosetta · R

attacco passante · P

articolo	misure (mm)					attacco
	A	B	C	D	E	
A. 502	360	300	130	70	60	P
A. 503	360	300	130	70	60	P
A. 506	295	230	80	75	37	R-P
A. 509	320	280	80	88	45	R-P
A. 514	336	230	90	68	44	R-P
A. 515	315	235	90	68	44	R-P
A. 516	307	230	90	68	44	R-P
A. 517	309	230	90	68	44	R-P
A. 560	260	215	115	79	45	R-P
A. 570	340	235	94	73	44	R-P

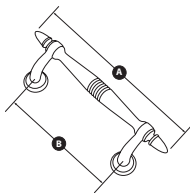



A 540



A 520



A 525



A 530



A 565



A 545



A 568



A 550



A 579



A 580



A 576 (1)

(1) Per utilizzare il DEFENDER, il cilindro deve sporgere dalla porta da 8 a 10 mm.

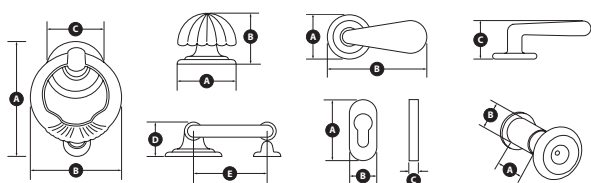

articolo	misure (mm)					attacco
	A	B	C	D	E	
A. 520	165	135	79	58	110	R
A. 525	163	110	79	63	107	R
A. 530	81	83	-	-	-	R
A. 540	155	118	79	60	100	R
A. 545	18/45	14	-	-	-	-
A. 550	50	104	60	-	-	-
A. 565	50	150	66	-	-	-
A. 568	61	95	60	-	-	-
A. 576	70	30	15	-	-	-
A. 579	61	31	10	-	-	-
A. 580	61	31	10	-	-	-



NUMERI CIVICI NEWENTRY

Anche i dettagli richiedono grandi Idee, così Newentry ha creato CIVIC.

Il numero civico dal design essenziale, composto da una placca in metacrilato satinato, sostenuta da due supporti, sulla quale comporre ed applicare il numero civico: supporti e numeri sono realizzati in acciaio inox satinato.

Con CIVIC eleganza e funzionalità si uniscono per un prodotto innovativo, studiato in armonia con lo stile dei maniglioni e delle pensiline Newentry per rendere ancora più esclusivo il tuo ingresso.



1 2 3 4 5

NC601
acciaio inox
satinato

NC602
acciaio inox
satinato

NC603
acciaio inox
satinato

NC604
acciaio inox
satinato

NC605
acciaio inox
satinato

6 7 8 9 0

NC606
acciaio inox
satinato

NC607
acciaio inox
satinato

NC608
acciaio inox
satinato

NC609
acciaio inox
satinato

NC600
acciaio inox
satinato

a b c d

NC600A
acciaio inox
satinato

NC600B
acciaio inox
satinato

NC600C
acciaio inox
satinato

NC600D
acciaio inox
satinato



NC651
Placca in plexiglas
per 1 numero

NC652
Placca in plexiglas
per 2 numeri

NC653
Placca in plexiglas
per 3 numeri

NC654
Placca in plexiglas
per 4 numeri

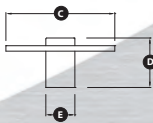
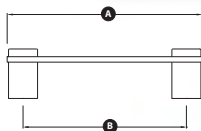

articolo	misure mm					attacco
	A	B	C	D	E	
NC651	190	155	120	54	32	Tassello da 8 mm
NC652	215	180	120	54	32	Tassello da 8 mm
NC653	265	230	130	54	32	Tassello da 8 mm
NC654	315	280	140	54	32	Tassello da 8 mm